

## ΜΑΧΑΙΡΙΑ ΣΒΟΛΟΤΡΙΦΤΗ

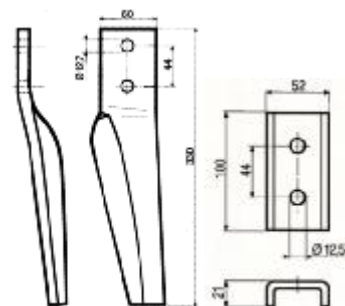

| Κωδ                      | Περιγραφή  | Διαστάσεις                             | Τιμή                   |
|--------------------------|--|--|------------------------|
| SB-001                   | <b>Maschio, Sicma,</b><br><b>Celli</b> Λάμα:90x12<br>Τρύπα:Φ17   | Απόσταση<br>ΚΚ:50mm<br>Ύψος:290mm      | <b>8.00</b>            |
| SB-268049                | <b>Maschio, Sicma</b><br>Λάμα:90x14<br>Τρύπα:Φ17                 | Διάκεντρο<br>50mm<br>L=:290mm          | <b>8.50</b>            |
| SB-255049                | Βάση SB-001  |  | <b>4.20</b>            |
| SB-255038                | Καλύπτρα maschio   |  | <b>3,75</b>            |
| 160558815                | Βίδα 16x1.5x55 8.8   |  | <b>0.85</b>            |
| 16055109                 | Βίδα 10,9 16X1,5X55  | 16X55                                  | <b>1.12</b>            |
| SB-065                   | Ξύστρα Sicma   | 105x84<br>36mm ΚΚ                      | <b>3.00</b>            |
| SB-064                   | Ξύστρα Maschio<br>3,5mm  | 42mm ΚΚ                                | <b>2.70</b>            |
| SB-003                   | <b>Maschio Acker</b><br>Λάμα:100X12<br>Τρύπα:Φ17<br>36100210/211 | Απόσταση<br>ΚΚ:60mm<br>Ύψος:310m<br>m  | <b>8,70</b>            |
| SB-255048                | Βάση SB-003  | 60mm                                   | <b>5.60</b>            |
| 38100907BA<br>38100907BΘ | Κουζινέτο Κυλίνδρου<br>maschio                                   | Αρσενικό<br>θηλυκό                     | <b>41</b><br><b>45</b> |
| SB-76208                 | ρουλεμάν   | 76208                                  | <b>16.00</b>           |
| SB-017                   | <b>Maschio</b><br>Λάμα:60X10<br>Τρύπα:13mm                       | Απόσταση<br>ΚΚ: 44mm<br>Ύψος:<br>332mm | <b>6.00</b>            |
| SB-255034                | Προστατευτικό<br>(ex SB-029)                                     |  | <b>2,60</b>            |

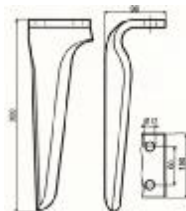
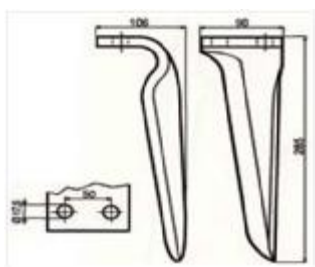

|          |                   |  |          |
|----------|-------------------|--|----------|
| SB-MAS21 | Maschio quick fit |  | No stock |
| SB-TRK02 | Turkey quick fit  |  | 18.00    |

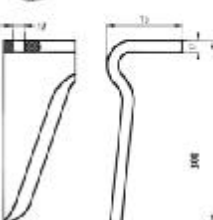
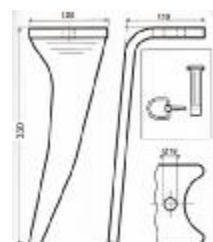
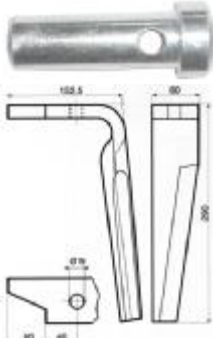
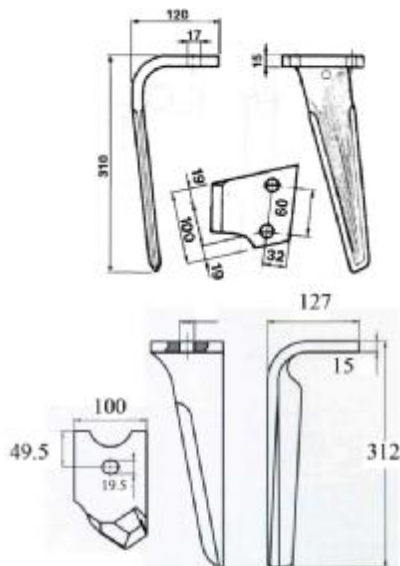

|              |  |                                    |              |
|--------------|--|------------------------------------|--------------|
| SB-113008    | <b>Alpego</b> Λάμα <b>110X15</b><br>Τρύπα 17mm       | Διάκεντρο 60mm<br>Ύψος 310mm       | <b>13,90</b> |
| SB-113014    | <b>Alpego Ταχείας</b><br>Λάμα 100X15 Τρύπα<br>19,5mm |                                    | <b>14.70</b> |
| SB-113A      | Πιράκι Alpego ταχείας                                |                                    | <b>1.60</b>  |
| SB-400013    | <b>Amazon</b><br>Λάμα 60X18                          | 1 Τρύπα<br>Ύψος:290mm              | <b>14,00</b> |
| SB-048       | <b>Amazon</b><br>Λάμα 60X15                          | 1 Τρύπα<br>Ύψος:290mm              | <b>13,00</b> |
| SB-400008    | <b>Amazon</b> 120x15 (ex SB-051)                     | 1 Τρύπα<br>Ύψος 330mm              | <b>19.50</b> |
| SB-6575300A  | <b>Amazon</b> 120x15 left IQ                         | 1 Τρύπα L330mm                     | <b>20.00</b> |
| SB-6574300A  | <b>Amazon</b> 120x15 right IQ                        | 1 Τρύπα L330mm                     | <b>20.00</b> |
| SB-18016-032 | Πίρος 16x55mm Amazon                                 |                                    | <b>0.84</b>  |
| SB-18016-036 | Ασφάλεια 6x20mm                                      |                                    | <b>1.20</b>  |
| SB-134032    | Breviglieri 100x12                                   | Απόσταση<br>ΚΚ:60mm<br>Υψος :310mm | <b>8.70</b>  |

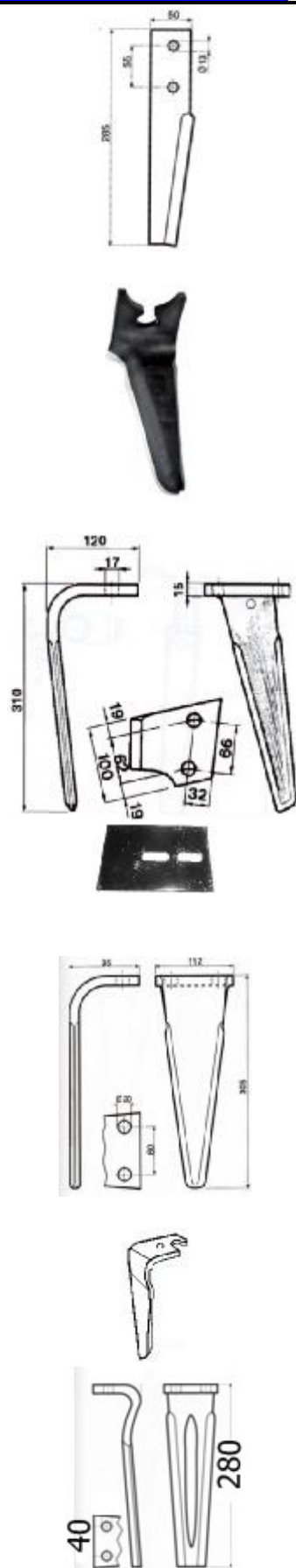

|                        |  |  |                              |
|------------------------|--|--|------------------------------|
| SB-DBR03               | Breviglieri Λάμα:50X12<br>Τρύπα:13mm<br>(ex SB-250)                                | 55mm                                       | <b>9.50</b>                  |
| SB-BRE40               | Breviglieri quick fit  | 100x15                                     | <b>15.00</b>                 |
| SB-153057<br>SB-172001 | <b>Celli 100x18x320</b><br><b>EMY</b><br>Λάμα 100X15<br>Τρύπα: Φ17,<br>(ex SB-009) | ΚΚ72 Τρ17<br>Διάκεντρο 66mm<br>Υψος :320mm | <b>11,50</b><br><b>12.00</b> |
| SB-172001A             | <b>Ξύστρα EMY (ex SB-009A)</b>   | 125x80mm<br>31x10/28x10                    | <b>2.60</b>                  |
| SB-FAL55               | <b>Falc ταχείας 100x14 57cc</b>  | Τρύπα 18mm                                 | <b>19,40</b>                 |
| SB-417006              | <b>Feraboli</b> Λάμα 100X15<br>Τρύπα 20 (Ex SB-162)                                | Απόσταση<br>ΚΚ:60mm<br>Υψος :320mm         | <b>13.00</b>                 |
| SB-417008              | <b>Feraboli</b> Λάμα 110X15<br>Τρύπα 20 Λοξό                                       | Απόσταση<br>ΚΚ:60mm<br>Υψος :320mm         | <b>13.20</b>                 |
| SB-417004              | Feraboli Λάμα 100X12<br>Τρύπα 17   | Απόσταση<br>ΚΚ:60mm<br>Υψος :320mm         | <b>9.00</b>                  |
| SB-178                 | <b>Feraboli 100x12</b>   | Υψος :290mm                                | <b>10.40</b>                 |
| SB-180                 | <b>Feraboli 110x15</b>   | Υψος 320 mm                                | <b>13.80</b>                 |
| SB-418009              | Forigo<br>Λάμα 95X12<br>Υψος 280mm   | ΚΚ 40mm<br>Τρύπα 14,5                      | <b>8.60</b>                  |

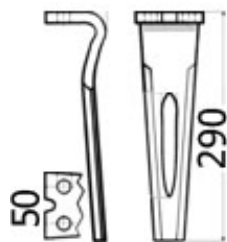

|           |                       |               |              |
|-----------|-----------------------|---------------|--------------|
| SB-418008 | Forigo<br>Λάμα 105X15 | ΚΚ 50 τρ 17mm | <b>12.30</b> |
|-----------|-----------------------|---------------|--------------|



|           |  |                        |              |
|-----------|--|------------------------|--------------|
| SB-005    | <b>Frudent</b>   | 54kk 17mm              | <b>10.70</b> |
| SB-172003 | <b>Concept Perugini</b><br>Λάμα 100X15<br>Τρύπα: Φ17 (ex ΣΒ-014) | ΚΚ:66mm<br>Υψος :320mm | <b>13,70</b> |

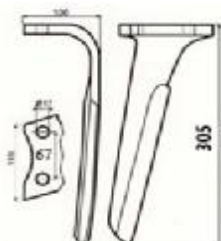

|           |   |                      |              |
|-----------|---|----------------------|--------------|
| SB-034    | Βάση Kuhn                                 | 68mm                 | <b>4.80</b>  |
| SB-225047 | <b>Howard-Rotavator</b><br>L=320mm 100x15 | CC 60mm<br>hole 14.5 | <b>10.00</b> |

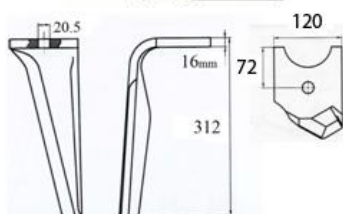

|           |   |      |              |
|-----------|---|------|--------------|
| SB-237021 | <b>Kuhn Λάμα 110X16</b><br>68mm ΚΚ Τρύπα: Φ17<br>H=320mm<br>52549430/52549530 | 68mm | <b>12.00</b> |
|-----------|---|------|--------------|

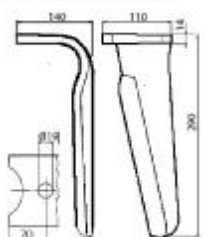

|           |  |         |              |
|-----------|--|---------|--------------|
| SB-237041 | <b>Kuhn Ταχείας</b><br>Λάμα 120x16<br>Τρύπα 20,5mm<br>K2500090<br>K2500010 | 1 τρύπα | <b>12,75</b> |
|-----------|--|---------|--------------|

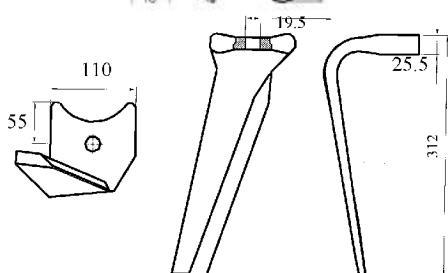

|              |  |                             |              |
|--------------|--|-----------------------------|--------------|
| SB-KUHN91/92 | <b>Kuhn Ταχείας</b><br>Λάμα 110x14<br>Τρύπα 20,5mm<br>K2500100 K2500090<br>2500081 | Κέντρο τρύπας σε άκρη 70 mm | <b>15.40</b> |
|--------------|--|-----------------------------|--------------|

|             |                                   |        |              |
|-------------|-----------------------------------|--------|--------------|
| SB-52596410 | <b>Κuhn ταχείας 52596410 δεξι</b> | 110x16 | <b>17.30</b> |
| SB-52596510 | <b>Κ2500071 52596510 αριστερό</b> | 110X16 | <b>17.30</b> |



|  |             |  |                                     |                     |
|--|-------------|--|-------------------------------------|---------------------|
|  | SB-PEG06    | <b>Pegolama 60x10</b>                                  | 16.5                                | <b>6.20</b>         |
|  | SB-DER64    | <b>Perugini</b>  | 60x12 65cc                          | <b>10.00</b>        |
|  | SB-PRG05D/S | <b>Perugini</b>  | 60x12 45cc                          | <b>7.00</b>         |
|  | SB-401331/2 | <b>Pottinger 110x18<br/>Hole 25.5<br/>873.40.225.3</b> | 110x18                              | <b>No<br/>stock</b> |
|  | SB-024      | Rabewerk<br>Λάμα 80X15<br>Τρύπα 14mm                   | Απόσταση<br>ΚΚ:40mm<br>Υψος :290 mm | <b>10.30</b>        |
|  | SB-448006   | Rabewerk 100x18<br>Αριστερό                            | ΚΚ 70mm                             |                     |
|  | SB-448005   | Rabewerk 100x18<br>Δεξί                                | ΚΚ 65mm                             |                     |
|  | SB-RIN05    | Rinieri λάμα 80x10<br>Τρύπα 14,5                       | ΚΚ 45mm                             | <b>7.00</b>         |
|  | SB-304017   | Sulky Perugini<br>Λάμα 100x14                          | 54ΚΚ<br>17mm                        | <b>11.70</b>        |
|  | SB-304017A  | Ξύστρα frandent<br>120x95 ΚΚ55mm 10.5                  |                                     | <b>2.30</b>         |

ΔΟΝΤΙΑ ΣΒΟΛΟΤΡΙΦΤΗ

|  | Κωδικός   | Τύπος             | Περιγραφή                              | Τιμή         |
|--|-----------|-------------------|--|--------------|
|  | SB-013    | Pecoraro          | Διάμετρος Υποδοχής 25mm<br>Ύψος 242mm  | <b>6,40</b>  |
|  | SB-015    | Pecoraro          | Διάμετρος Υποδοχής 30mm<br>Ύψος 300mm  | <b>11.00</b> |
|  | SB-DER62  | Pegoraro          | Διάμετρος Υποδοχής 32mm<br>Ύψος 320mm  | <b>17.00</b> |
|  | SB-400002 | Amazon            |  | <b>14.60</b> |
|  | SB-333    | TB333 Breviglieri | Διάμετρος Υποδοχής 32mm<br>Ύψος 325 mm | <b>18.00</b> |
|  | SB-303707 | Krone 426003      | Φ35                                    | <b>14.00</b> |
|  | SB-026    | Sicma E-24        |  | <b>10,20</b> |

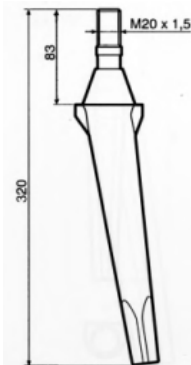
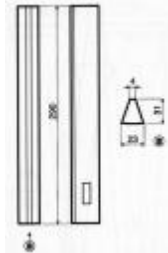
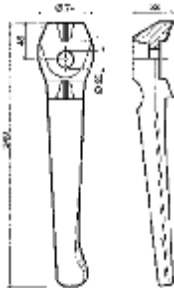
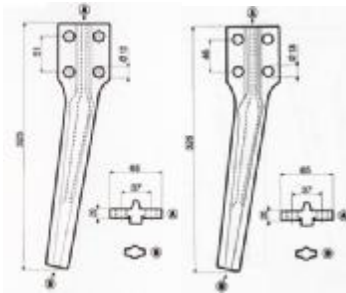

|           |                  |                 |              |
|-----------|------------------|-----------------|--------------|
| SB-65-51  | Eberhardt        | 51mm Διάκεντρο  | <b>16,20</b> |
| SB-65-46  | Eberhardt        | 46mm Διάκεντρο  | <b>16,20</b> |
| SB-435002 | Lely             | 23mm ισιο       | <b>8,70</b>  |
| SB-435004 | Lely             | Κωνικό          | <b>12.00</b> |
| SB-435007 | Lely<br>Αριστερό | δεξι-<br>κωνικό | <b>17.20</b> |
| SB-435010 | Lelly glob       |                 | <b>16,40</b> |
| SB-301501 | Carraro          |                 | <b>9.00</b>  |
| SB-451001 | Remac            |                 | <b>11.70</b> |
| SB-451002 | Remac            |                 | <b>12,35</b> |
| SB-427001 | Kuhn 1 hole      | 18mm hole H=320 | <b>8.80</b>  |